

PACE 500

PACE 500 OWNER'S MANUAL

AVENTON

AVENTON PACE 500 OWNER'S MANUAL

Thank you for purchasing an Aventon Pace 500 ebike! Before riding, please take a moment to review these instructions.

Need service or support? Visit our website for quick answers, manuals and live chat support, and/or give us a call and we'll find you a solution.

Aventon Bikes
18457 Railroad St
Industry, CA 91748
Phone: (866) 300-3311
Email: info@aventon.com

CONTENTS

| | |
|--|----|
| Display / Control Specifications | 1 |
| Getting Started | 2 |
| What's on the Display? | 3 |
| Using the Controls | 4 |
| Customizing the Display | 5 |
| • Function 01P Backlight Brightness | 5 |
| • Function 02P Unit of Measure | 5 |
| • Function 03P Battery Voltage | 5 |
| • Function 04P Wheel Size | 6 |
| • Function 05P Speed Limit | 6 |
| • Function 06P Odometer Reset | 6 |
| Battery and Charging | 7 |
| Maintenance and Service | 9 |
| Safety | 10 |
| Error Codes and Troubleshooting | 11 |
| Frequently Asked Questions | 14 |
| Notes | 18 |



DISPLAY / CONTROL SPECIFICATIONS

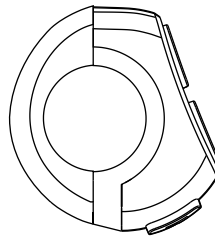
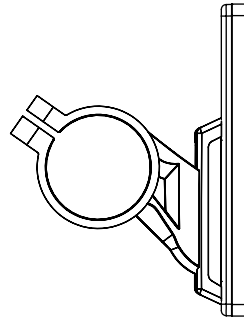
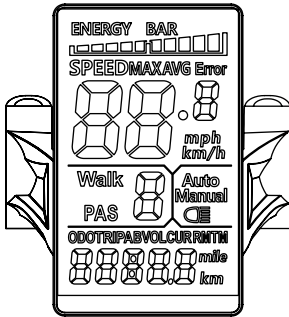

- 48 Volt Power Supply
- Current Rated: 10mA
- Maximum Operating Current: 30mA
- Power Off Leakage Current < 1uA
- Operating Current to Controller: 50mA
- Operating Temperature: -18° to 65°C
- Storage Temperature: -30° to 80°C



GETTING STARTED

The Pace 500 is operated using the control pad on the handlebars. The control pad is located near the left-hand brake lever.

First, tap the power button on the battery to turn on. The current charge level will be temporarily displayed on the LEDs (4 = full, 1 = near empty), then one green LED to show the battery is turned on. Next, press and hold the  button on the handlebar controls to turn on the display. Now, your e-bike is ready to ride. To turn off, press and hold  for 3 seconds.

The Pace 500 ebike offers pedal assist. When using pedal assist, an electric motor supplements the rider's own effort. To use the pedal assist, simply start pedaling, then tap the  or  arrows to increase or decrease the amount of pedal assist from levels 0-5. Pedal assist will engage at speeds up to 28 MPH.

The Pace 500 ebike is equipped with a throttle, which is mounted near the rider's left thumb, to propel the bike without pedaling. To use the throttle, start pedaling then apply the throttle. Once the bike is moving on throttle power, you can stop pedaling entirely and use your thumb to control the speed of the bike. The throttle can propel you at speeds up to 20 MPH.

The motor stops when you: stop pedaling, squeeze the brake levers, or release the throttle. Simply start pedaling again to re-engage the motor.



WHAT'S ON THE DISPLAY

While you are riding, you can use the display to monitor your speed, the amount of pedal assist, battery life remaining, and other data.

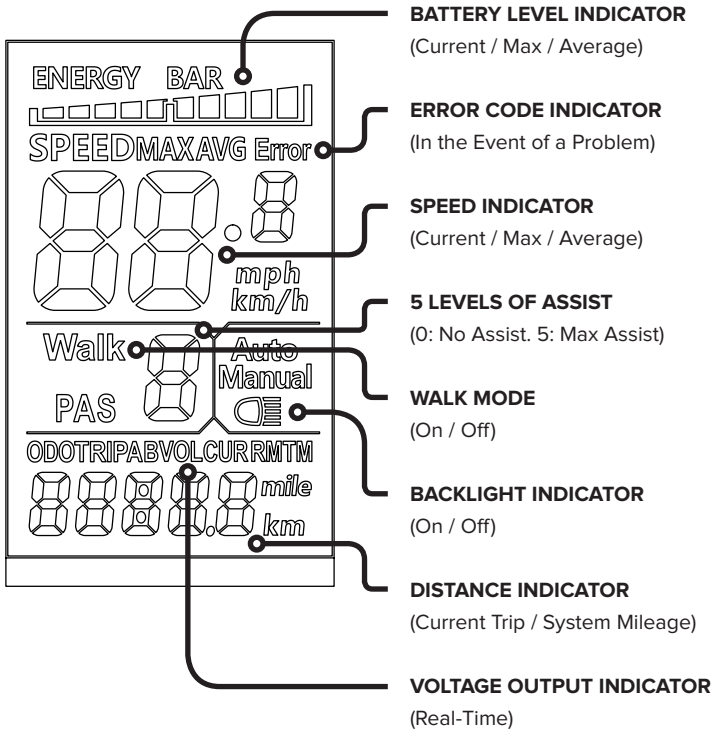

As shown below, your Pace 500 uses a LCD display screen that looks like this:





USING THE CONTROLS



To turn on your bike, tap the power switch on the battery, then press and hold the  button for 3 seconds. To turn off, press and hold the  button for 3 seconds, then press and hold the power button on the battery for 2 seconds. The display and battery have an energy-saving feature, if there is no activity for 10 minutes, they will turn off automatically to preserve battery life.

Tap the  or  arrows to change the level of pedal assist.

Hold  and  for 3 seconds to switch between showing real-time speed, average speed, and max speed.



Tap  to toggle between the display of the Odometer, Trip Distance, Voltage, and Elapsed Time.





Press and hold  for 3 seconds to enable the backlight on the display. Press and hold  again for 4 seconds to turn it off.

To enable walk mode, first come to a complete stop and stand next to the bike. Press and hold  for 3 seconds. The bike will slowly move forward at 3.5 MPH / 6 KPH as long as you hold the  button. This feature is useful for pushing the bike up a hill or walking through a crowd, where you cannot safely ride.

“Super walk mode” is an even-faster version of walk mode. To use it, hold the down arrow to engage standard walk mode, then press the throttle. This is useful on very steep climbs or when towing a trailer. Use caution with both walk modes.

CUSTOMIZING THE DISPLAY

You can use the settings features of the display to customize the Pace 500 for your use. To enter the “Settings” mode, hold the  and  buttons at the same time for 2 seconds.

You can customize 5 out of the 6 different functions on the display. Tap the  button to move from function to function, and use the  and  arrows to adjust each to your preferences. When you are finished, press and hold the  button to save your changes. *Note: The system will save your changes automatically after 8 seconds.*

FUNCTION 01P - BACKLIGHT BRIGHTNESS

You can control how bright you'd like the display backlight to be. 1 being the dimmest and 3 is the brightest.

FUNCTION 02P - UNIT OF MEASURE

You can toggle between miles or kilometers, based on your location and preference.

FUNCTION 03P - BATTERY VOLTAGE

This function sets the battery voltage of the system. On the Pace 500, this function is locked at 48V to match the battery and motor, and cannot be changed.

FUNCTION 04P - WHEEL SIZE

This function can be used to change the wheel size to 16, 18, 20, 22, 24, 26, 27.5, or 28" wheels. The Pace 500 comes stock with 27.5" wheels, which is the default and recommended setting. *Note: Selecting the incorrect wheel size will affect the accuracy of the bike's speed, the odometer, and the functionality of its pedal assist.*

FUNCTION 05P - SPEED LIMIT

The Pace 500 is a California Class III ebike. This designation carries a pedal assist limit of 28 MPH (45 KPH). You can pedal faster without assist, but the motor will stop providing assist when the speed limit is reached. You can use the Speed Limit function to change the speed limit based on your preferences and the law in your area. The Speed Limit function can be set from 20-51 KPH (for reference, that is 12.4 - 31.7 MPH) and is always set in KPH. You should only set the Speed Limit to a value that is safe and legal in your community. This function does not affect the max speed on throttle, which is locked at 20 MPH (32 KPH).

FUNCTION 06P - ODOMETER RESET

The odometer tracks the distance you've ridden over the lifetime of your bicycle. Press and hold  for 5 seconds to reset the trip distance from a single trip.

BATTERY AND CHARGING

The Pace 500 uses a Lithium-Ion battery which can be charged on or off the bike. We recommend charging the battery off the bike indoors, in moderate temperature conditions. To charge the battery, plug the charger into the charging port and then connect the charger to a wall outlet. The LED indicator light will be red when charging and will turn green when charging is complete. When finished, unplug the the charger from the wall outlet.

Take care of the battery to ensure a long service life:

- Charge and store the battery indoors if possible. The battery can be removed from the bicycle for this purpose.
- Avoid extreme hot and cold temperatures.
- DO NOT submerge your bike or any of the components in water. This action will void the warranty.

To optimize the performance of the battery over time, try and use it (discharging and charging) at least monthly. But if you won't be riding your Pace 500 for a long period of time, it's best to store the battery fully charged.

After many charging and discharge cycles, runtime and range will be reduced. Replacement batteries are available from Aventon to extend the life of your ebike. The lifespan of the battery is about 500 charge / discharge cycles.

When you install the battery on the Pace 500, it locks into place automatically. To unlock it for removal, use the supplied key. Do

not ride the bicycle if the battery rattles or moves - it should be firmly attached.

The Pace 500 battery contains a USB port for transmitting diagnostic data only, not for charging. It will not charge or power devices via USB.

MAINTENANCE AND SERVICE

Properly maintaining your Pace 500 ensures its longevity and smooth operation. Before assembling your bike, please watch the “How To Assemble” video we’ve prepared for you. If you have questions during the assembly process, please contact Aventon at (866) 300-3311 or email info@aventon.com.

Once you’re up and running, please make sure to:

- When cleaning your bike, use a damp cloth and gentle dish soap. *Note: DO NOT use a pressure washer or sprayer.*
- Periodically apply a light lubricant to moving parts, including the links of the chain, derailleur pivots, and shifter cable inner wire where it enters the cable housing.
- If you ride in wet / humid environments clean and dry electric connections and apply an anti-corrosive.

All bicycles will need a periodic tune-up or adjustments by a professional. An annual “check-up” is beneficial. Your bike’s service schedule will depend on the frequency of its use. In between expert services at a bike shop, we suggest:

- Keep tires inflated to their recommended pressure (30-50 PSI / 2.0-3.5 BAR / 200-350 KPA) and check weekly.
- Clean the drivetrain and lubricate the chain (monthly)

For more information about further recommended maintenance, we suggest the excellent video series offered by Park Tool.

SAFETY

You should wear an approved bicycle helmet every time you ride a bicycle, regardless of the legal requirement to do so. Additionally, some jurisdictions require helmet use when riding Class III ebikes like the Pace 500. You should comply with local law when riding your Aventon bicycle.

Your Pace 500 comes with reflectors and we encourage you to install and use them. Reflectors are not a substitute for lights, which are not included with your bicycle. You should purchase, install, and use front and rear lights when riding in dim or dark conditions.

Some jurisdictions restrict where ebikes can and cannot be ridden. These limits may include specific speeds and motor wattages. Your Pace 500 is a California Class III ebike, 500 watts with pedal assist up to 28 MPH and throttle up to 20 MPH. You should only ride it where legal and safe.

Your Pace 500 will run without the throttle plugged in. You can remove the throttle to comply with local regulations if needed.

ERROR CODES AND TROUBLESHOOTING

In the event of a problem with the electrical components of your bike, the display will show an error code. Compare the code with this list below and **HOW TO RESOLVE**:

| CODE | ERROR | HOW TO RESOLVE |
|------|-------------------------|--|
| 21 | Current Error | Check the cable that connects the rear hub motor to the rest of the system. Make sure it is free from grit or contaminants and is firmly connected. |
| 22 | Throttle Error | When you press and release the throttle, it should return to the original position. Remove any obstructions. Check the throttle and throttle cable for damage, such as a cut or frayed cable. |
| 23 | Motor Phase Error | Check the cable that connects the rear hub motor to the rest of the system and make sure it is free from grit or contaminants and is firmly connected. This error might appear if you don't reconnect the cable after removing the rear wheel (for example, after changing a flat tire, or transporting your bike in the trunk of a car). At least one of the motor phase wires has been damaged or is temporarily disconnected. |
| 24 | Motor Hall Sensor Error | The hall sensor inside the rear hub might be disconnected or damaged. Service or replace the rear hub. |

| | | |
|----|-----------------------|---|
| 25 | Brake Error | The Pace 500 uses special brake levers that stop the motor when you apply the brakes - built in "magnetic reed switches" disengage the motor's power when the lever is squeezed. If the lever is damaged (for example, following a crash), it might need to be replaced. |
| 28 | Low Voltage | The voltage supplied by the battery is too low to operate the bike. Charge the battery and try again. If the issue persists, check the voltage output on the battery terminals using a volt meter. |
| 29 | Over Voltage | The battery is supplying too much voltage to the controller. Make sure you are using the correct battery for your bike. For example, the 36V Pace 350 battery will not work with the 48V Pace 500, triggering the error. |
| 30 | Communication Error | Poor connection between the controller and the display, check all cable connections. |
| 38 | Battery Voltage Error | The battery is not supplying the required voltage to power the display and motor. Use the display to view the real-time voltage being output from the battery. It can also be checked using a volt meter. If the battery is old and has been charged / discharged many times, it may need to be replaced. This error could also appear if you install the wrong battery on your Pace 500. |

| | | |
|-----|------------------------|--|
| E1E | Communication Error | Bad connection between display and controller, disconnect and re-connect display; ensure connection does not have grit or contamination. |
|-----|------------------------|--|

ADDITIONAL TROUBLESHOOTING

Having trouble with your Pace 500? Most problems are easy to correct.

1. Start by making sure you have a charged battery. You may wish to leave the battery on the charger overnight to ensure a 100% charge before doing additional troubleshooting.
2. If the motor of your bike will not engage, or only engages intermittently, doublecheck the cable connection where the rear wheel motor plugs into the rest of the system. This connector must be firmly and fully plugged in to function correctly. If necessary, loosen the clips holding the cable to the frame to create additional slack in the cable, then re-tighten the clips after you have the motor cable firmly plugged in.
3. The throttle on the Pace 500 will only engage after the motor is turned on via pedal assist. This is a safety feature designed to prevent you from accidentally engaging the throttle while parking or walking the bike. If you have having difficulty with the throttle, remember to make one revolution of the pedals first, then engage the throttle. You can stop pedaling after the throttle function turns on.
4. If you bent the derailleur hanger on your Pace 500 in a fall, don't worry. It's actually designed to fail, sparing the more expensive frame, and is inexpensively replaceable for this reason. We've included a spare rear derailleur hanger in the accessory box "just in case." If you need more, they are available on [Aventon.com](https://www.aventon.com) or at partner bike shops.

5. If your bike powers up normally and shows no error messages, but will not run when you turn the pedal assist on, check to ensure the cadence sensor under the left crankarm is plugged in.

FREQUENTLY ASKED QUESTIONS

- **Do the components of the Pace 500 and Pace 350 ebikes interchange?**

Some components interchange across the line of Pace ebikes, like saddles, seatposts, handlebars, and grips.

The ebike-specific components, however, like batteries, controllers, displays, and motor do not interchange. Pace 350 is a 36V system vs. 48V on the Pace 500 and these parts are not compatible.

- **My Pace ebike is too fast for me, or exceeds my local speed limit, or only Class I ebikes are allowed on my favorite bike path.**

Pace ebikes can have the speed limit changed using the settings in the control panel and can be set as low as 14 MPH if desired to comply with local laws. Pace ebikes can also have the throttle unplugged and removed (but will continue to run on pedal assist) if desired in locations where throttle bikes are not permitted.

- **On the Pace line of ebikes, I can't use the throttle from a dead stop, only once I'm pedaling. Why?**

This is a safety feature to prevent you from accidentally engaging the throttle while parking or standing with the bike, if you forget to turn it off and then hit the throttle accidentally. You can engage the throttle at any time while you are pedaling. If you are at a dead stop, you can push the throttle, start pedaling (about one pedal revolution), then stop pedaling, and the bike will stay in throttle mode.

- **How many times can I recharge my ebike battery?**

Lithium-Ion ebike batteries use a similar technology to your laptop or mobile phone. They can absorb about 500 charging cycles before performance starts to degrade. Afterwards, they can continue to be recharged, however, their capacity will decrease.

- **Can I put a suspension fork on the Pace ebike?**

Yes, it is possible to put a suspension fork on the Pace line of ebikes. You would need a replacement fork with these specs: 1 1/8" to 1.5" tapered steerer tube, 51mm IS mount for disc brakes (or a 74mm mount with an add-on adapter to 51mm), 27.5" / 650B wheel size, and the quick release / open type dropout style. Selecting and installing a suspension fork is probably a job for a bike shop.

- **Can I put a suspension seatpost on the Pace ebike?**

Yes, you can add a suspension seatpost to your ebike. Shop for a model with the same diameter as the seatpost you are replacing. The seatpost diameter is stamped on the post, near the minimum insertion mark.

- **How fast can the Pace 500 go?**

We ship the Pace 500 ebike in a "Class III" configuration to meet ebike laws which have been adopted in many states. The user can modify the speed limit using the settings, for example, if you live in a state without ebike laws, or if you are riding on private property. During our testing, we have found that the Pace 500 can achieve about 31 MPH on flat ground if you remove the speed limit.

- **Do I have to wear a helmet when riding an ebike?**

This depends on the specific ebike class you are riding (I, II, or III), your age, and your state. For more information, [visit this page](#) and click on your state.

- **What rear rack fits the Aventon Pace e-bikes?**

We recommend the [Planet Bike Eco Rack](#). The Pace 500 size S and M need an add-on Planet Bike Extended Length mounting kit. The Pace 500 size L does not need this kit. The Pace 500 Step-through in size S and M need the extended length mounting kit.

- **How should I care for my e-bike battery?**

Please read this article, [Caring for your ebike battery](#).

- **How can I calculate the capacity of an e-bike battery?**

Ebike battery capacity is measured in Watt-Hours, or Wh. This is the size of the “fuel tank” on the ebike. Like a car, some motors guzzle fuel, others sip. To calculate the capacity, multiply the voltage (V) used on the bike by the Ampere-Hour (Ah) rating. For the Aventon Pace 500, for example, multiply 48V by 11.6Ah = 556.8 Wh. More Watt-Hours equals more range for your ebike.

- **Why does the amount of battery remaining shown on the LEDs on the battery not match the “Energy Bar” on the display?**

The green LEDs on the battery itself show the remaining charge left in the battery, but this doesn’t account for how you are using the bike. The Energy Bar function on the display is designed to account for the charge on the battery plus other

factors, like speed, throttle usage, and riding conditions like hills or wind. You'll see it fall quickly under heavy usage, and more slowly when you are not taxing the motor.

- **What are the weight limits for the Pace 500?**

Maximum Rider Weight: 250 LB / 113.3 KG

Maximum Cargo Weight: 50 LB / 22.6 KG

NOTES

AVENTON

WWW.AVENTON.COM