

# magnum

## *Pathfinder 500W*



**PLEASE READ ME FIRST**

[www.magnumbikes.com](http://www.magnumbikes.com)

# General Introduction

## WELCOME

Thank you for purchasing a Magnum electric bike and welcome to the Magnum Bikes family of e-bike enthusiasts. We encourage you to join our Facebook group "Magnum Bikes Community" which you can find at the following link:

<https://www.facebook.com/groups/389290978573773>

Our Facebook group is a place for Magnum riders to ask questions, have discussions, share recommendations and experiences and connect with other Magnum Bike enthusiasts.

## USE OF THE MANUAL

We encourage you to read this manual thoroughly before you take your new E-bike for a ride. It is important not to overlook the safety instructions and explanations of both traditional and non-traditional bike parts, as this will offer you a general understanding of your new E-bike. This manual is designed to help you get the most out of your E-bike, and so we have attempted to answer as many of your potential questions as possible. Please take a moment to read through the various sections before you get in the saddle.

## SERVICE AND TECHNICAL SUPPORT

This manual is intended as a general overview of your new E-bike, and is therefore not an extensive reference. For technical support, including information about service, maintenance and repairs, please consult your dealer. You can visit our website ([www.magnumbikes.com](http://www.magnumbikes.com)) for more information about our products and technology, or to find a dealer close to you.

# INCLUDED WITH THE PATHFINDER E-BIKE



Charger



Allen Wrench



Phillips  
Screwdriver



Open End  
Wrench

Display

Stem

Headlamp

Front Fender

Front Disc Brake

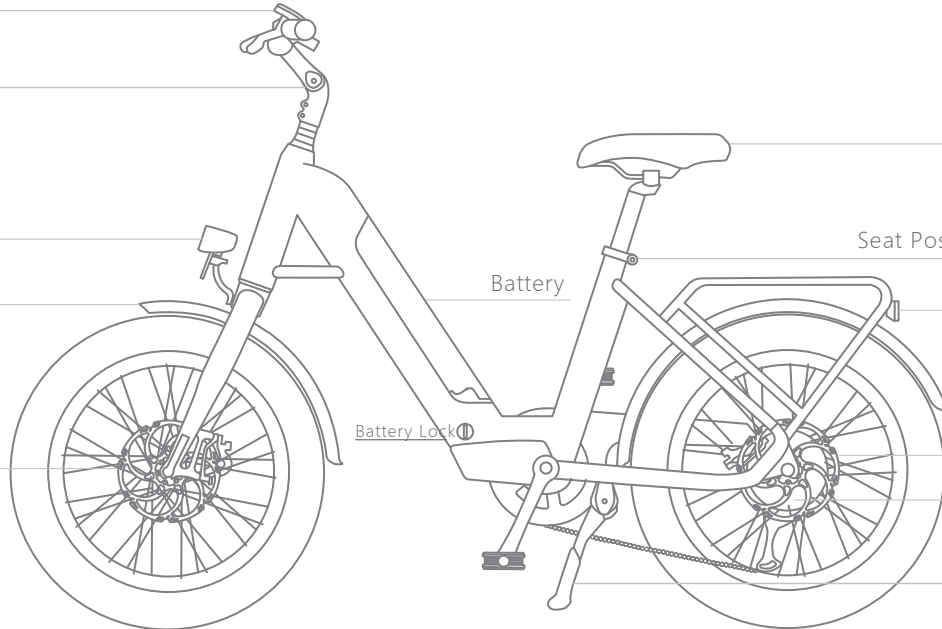

Battery

Battery Lock

Saddle

Seat Post Clamp

Tail Light

Rear Disc Brake

Motor

Kickstand

## Unpacking & Assembling

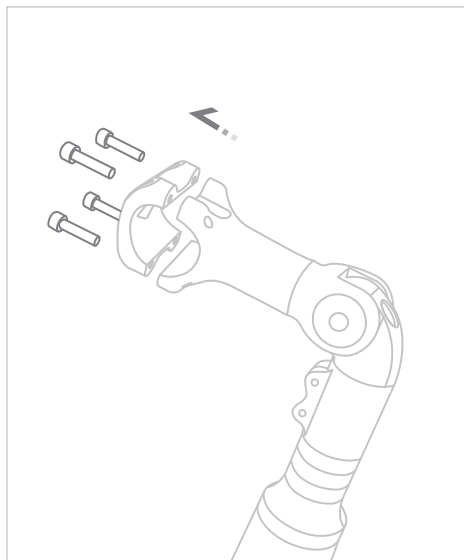

STEP 1. Install the handlebar and stem

- ① Turn out the front end screw of the stem
- ② Open the front cover of the stem and put the handlebar into it. Adjust the angle of the handlebar

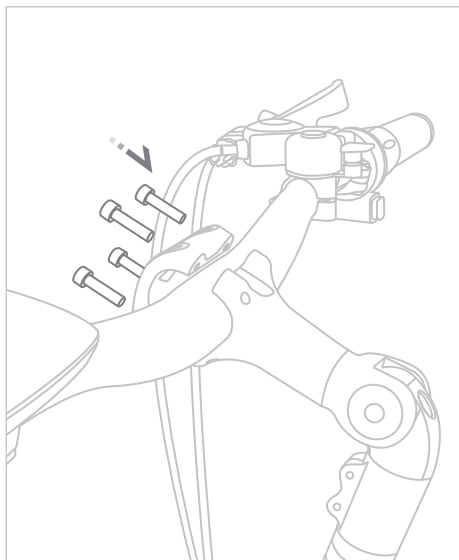

- ③ Tighten the screw at the upper end of the stem and lock the handlebar
- ④ After installation, move the handlebar back and forth to make sure the screws are tightened

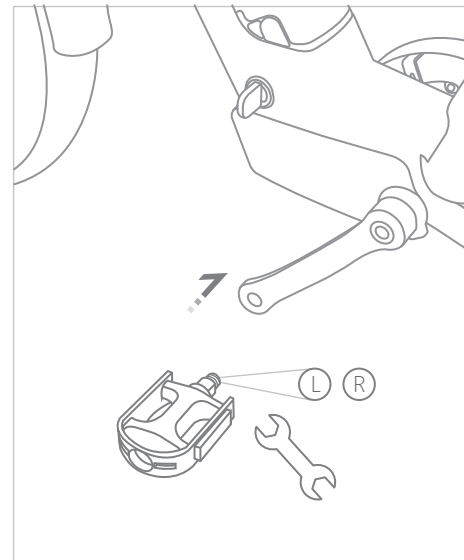

STEP 2. Install pedals

- ① Take out the pedal and tool kit from the accessory box. L (left) and R (right) are engraved on the end of the foot screw.
- ② Screw in the pedal, left counterclockwise, right clockwise and finally tighten with an open-end wrench.

## Parts Introduction

- ① Display
- ② The left brake lever controls the rear disc brake
- ③ The right brake lever controls the front disc brake
- ④ Electronic horn
- ⑤ Gear shifter
- ⑥ Throttle
- ⑦ Stem adjustment

### Brake lever adjustment and fixing

Adjust the angle of the brake lever to a comfortable position, and then tighten the screw above the brake lever with the allen wrench from the include tool kit.

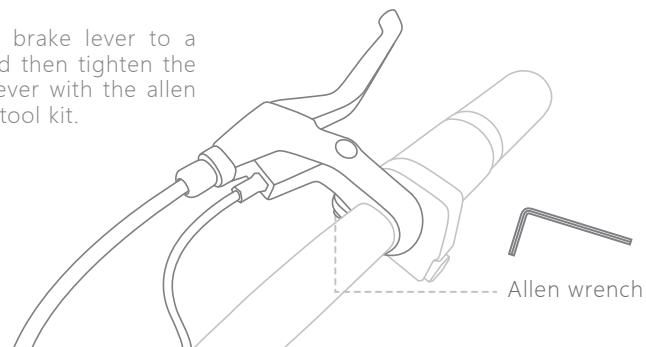

### HANDLEBAR HORIZONTAL ADJUSTMENT

When unpacking and assembling, adjust the horizontal angle of the handlebars with stem adjustment ⑦. Adjust to desired or comfortable horizontal position and finally tighten the stem adjustment with provided tool kit.

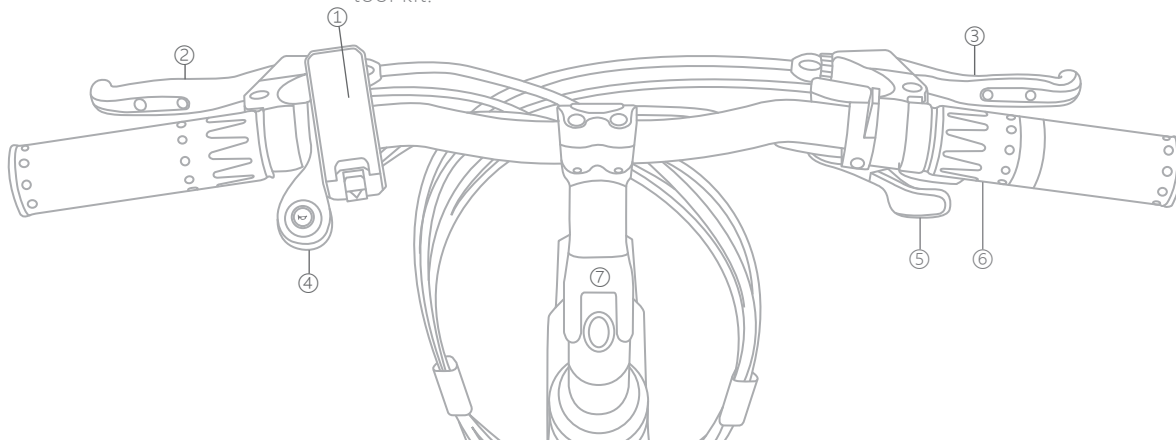

## Battery

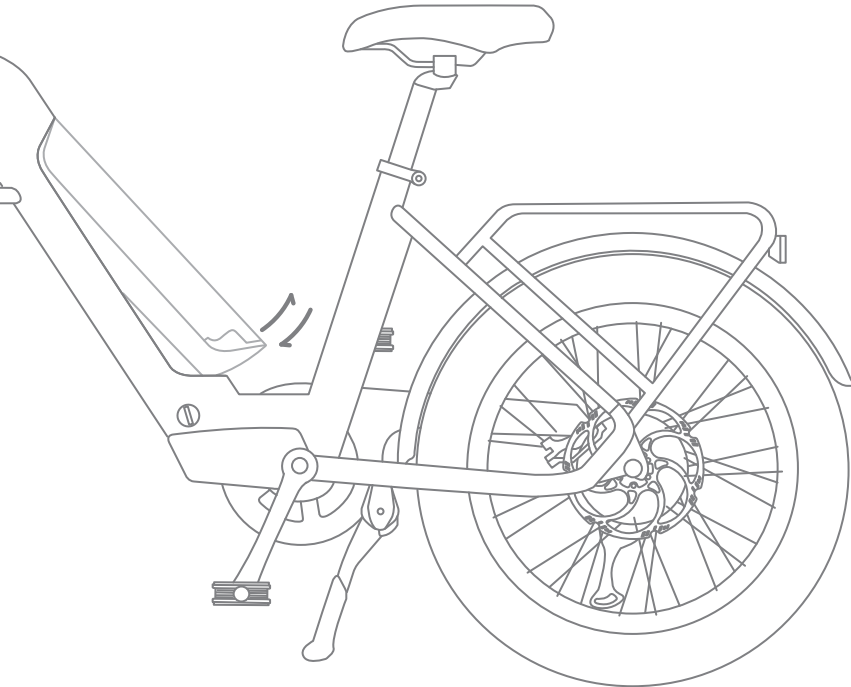

## BATTERY REMOVAL

Insert the key into the lock hole on the side of the e-bike and twist it to the battery unlock position, then the battery can be taken out.

## BATTERY INSTALLATION

Key is in the lock hole on the side of the battery in the unlock position, then place the battery into the slot and twist the key to the lock position. Remove key.

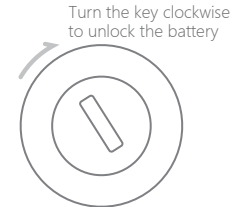

BATTERY LOCK

## BATTERY SAFETY

Do not leave the battery unused for a long time, take it out and charge it at least once a month. Battery failure caused by improper or irregular charging is not covered by the warranty.

Try not to exhaust the battery completely during riding. Charge it as soon as possible at the last bar of the battery indicator on the meter. Complete exhaustion of the battery will affect the battery life.

Waterproof instructions: The battery casing protects from basic rain while inserted and riding. Do not leave the whole e-bike in rain for a long time. After exposure to light rain wipe battery dry as soon as possible.

**DO NOT** submerge the battery or allow heavy rain exposure.

# Product Specs

## ELECTRONIC DETAILS

Motor Type:  
Rear Geared Hub Motor  
Motor Output:  
48v 500w  
Battery Voltage / Amp Hours / Watt Hours:  
48v / 13ah /624wh  
Battery Chemistry:  
Lithium Nickel Cobalt Manganese (Li-ncm)  
Estimated Charge Time:  
4-4.5 Hrs  
Estimated Min And Max Range:  
30 To 50 Miles (Depending On Riding Style,  
Terrain, Rider Weight, and Pedal Assist Level.)  
Display Type:  
Bigstone H102 Display  
Display Readouts:  
Speed (mph or kmh), Frontlight on/off, Assist  
Level 0-3, Battery Level, Odometer, Trip Distance,  
Range (estimated remaining mileage)  
Drive Modes:  
Pedal Assist, Twist Throttle  
Max Speed:  
25mph  
Lights:  
Integrated Front and Rear Light controlled by the  
display (power on/off)

## BICYCLE DETAILS

Total Weight:  
50lbs  
Battery Weight:  
8lbs  
Frame Type:  
Low Step  
Fork Details:  
Fixed Alloy  
Gearing Details:  
Shimano Altus 7 Speed  
Shifter Details:  
Shimano Altus  
Stem:  
Adjustable Alloy  
Brake Details:  
Tektro Hydraulic disc brakes  
Saddle:  
VELO saddle  
Seatpost:  
Rigid  
Rack / Fenders:  
Rear rack, front and rear fenders  
Tires:  
Innova 20" fat tire  
Wheel Size:  
20" x 3"

# Safety

## PRECAUTIONS

- When adjusting the handlebars or saddles, be careful not to expose the safety line marks of the handlebars and saddles
- Before cleaning the e-bike, please turn off the main power supply and unplug the charging cable
- Note about water washing: It is strictly forbidden to directly wash or soak the e-bike with a high-pressure water gun or water pipe, and it is strictly forbidden to wash with water
- This product has a certain rain-proof function, please dry it in time after riding on rainy days, do not rain for a long time

## BATTERY CHARGING & MAINTENANCE

- Charge at 0°C ~ 40°C, discharge at -20°C ~ 50°C, keep the battery dry and ventilated
- When there is only one battery power indicator or the meter shows only one bar left, please turn off the power and charge it in time. The exhaustion of the battery will seriously affect the battery performance and life. Please turn off the electric door lock when charging
- Do not leave your battery charging overnight.
- Please use the original charger, pay attention to the battery type and voltage applicable to the charger
- The charger lights up in red during charging, and turns to green when fully charged. Please unplug the charging head when the battery is full.
- Please close the rubber cover of the charging port after charging, otherwise it will affect the rainproof effect and cause damage to the battery
- When replacing the charger, it should match the battery model
- It is strictly forbidden to put the battery in acid or alkaline liquid, try to avoid rain, keep away from fire, heat and high temperature. It is strictly forbidden to destroy or disassemble the battery. Do not insert metal objects into the charging port to avoid short circuit.
- Used batteries cannot be dismantled without authorization, and should be recycled by relevant professional departments





# *Pathfinder Display Manual*

## Specification of H102 Display



## 4. Key Functions

H102 display is included 3 buttons, the distribution position is shown in the figure below, and the functions are as follows:

 Power key, for switching machine and function confirmation, and information switching function.

 Adjust and increase the button, which is used to adjust the power gear, select the setting options and switch the lights.

 Adjust and reduce buttons for power gear adjustment, setting options selection and 6KM start assistant.

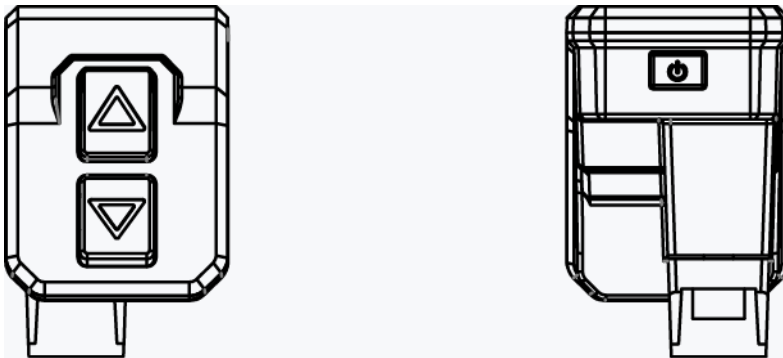

## 6. Functional Overview

### 6.1. Switch on and off machine operation and display

Shut down state, continue to press down  2 seconds, The meter displays the welcome form and then enters the main form of the system.

In the power on state, press continuously  2 seconds, the meter displays the shutdown form and then the system shutdown. The button can be released.

### 6.2. Main form and operation

H102 provides you with a variety of displays to meet your riding needs. The display content of H102 includes:

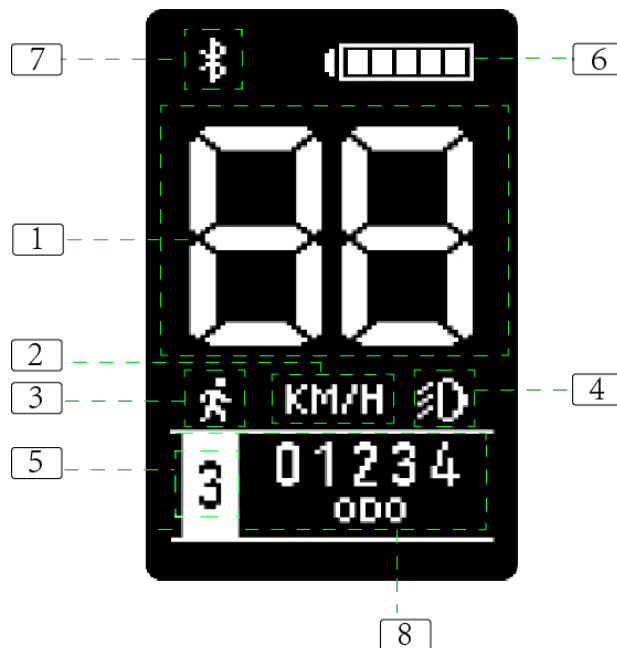

1 Speed display :

## Specification of H102 display

---

Shows the speed of the current ride.

### ② Speed unit display:

You can set the select speed unit by km/h or mph.

### ③ 6KM Display:

When the power gear is not 0, Continuous press  , for opening the 6km implementation function, This location will displays the 6km icon.

### ④ The lights display:

Power On mode, hold the key  , more than 2 seconds, for opening or turning off the lights.

### ⑤ assistant level display:

Display the current assistant level, turn on the default level 0, adjustable range 0-6, and the 6th level may be hidden, but can be hidden or closed by setting items.

### ⑥ Battery level display :

Display current battery power information. The battery is full of electricity, showing full, and when the last level starts flashing, the tip needs to be charged to the battery.

### ⑦ Bluetooth instructions:

When the instrument is connected to the machine via Bluetooth, the Bluetooth logo is displayed here. If the instrument is in the Bluetooth online mode, the Bluetooth logo will continue to shine until it is reconnected to the machine. There is no this item without Bluetooth configuration.

### ⑧ Information display:

## Specification of H102 display

---

- i. ODO: Shows the mileage accumulated by the user.
- ii. TRIP: Display the user's cycling mileage. The single mileage will not be cleared when power off. The user needs to reset the mileage manually in the setting interface.
- iii. RANGE: Remaining mileage. The remaining mileage is an estimate that may differ from the actual ride.

### 6.3. Average speed and maximum speed display

Under the normal speed display interface, press the key and the key at the same time to enter the average speed and maximum speed display page, as shown below:





Average speed refers to the average speed of the vehicle up to the moment of starting up, and the maximum speed is also the maximum speed recorded so far in this starting up. After shutdown and restart, the average speed and maximum speed start recording and calculation again.



Press any key once to exit the average speed and maximum speed display.

## 6.4. Setting item description and operation

### 6.4.1. Enter and exit the Settings page and instructions for the Settings

Press the key  and  at the same time to enter the setting interface. The meter on the setting page is displayed as follows:



In the Settings page you can select  and  to modify or display the items.

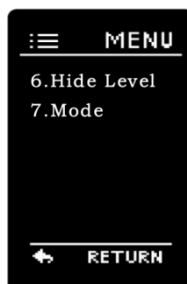

After the item is selected, press the key  to confirm the perforation

If more than one page is displayed, there will be PAGE DOWN under the display area. Select PAGE DOWN to enter the next page.



## Specification of H102 display

---

In the Settings page, press  and  at the same time can quickly exit the Settings page, back to the main page display.

### Wheel setting and display

Select the TIRE SIZE, and then press the key  to enter the Wheel Diameter Setting and Display Items page.

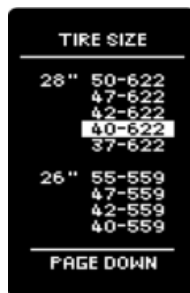

If the vehicle controller has fixed the vehicle wheel diameter size, this numeric term will not be adjustable and will only be used to display the system wheel diameter size.

### 6.4.2. Unit settings and display

Select the UNITS, and then press the key  to enter the Unit Settings and Display Items page.

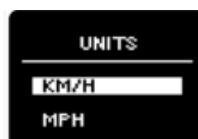

---

## Specification of H102 display

---

Users can adjust the display unit of mileage and speed according to actual needs. Choice of metric or British units.

### 6.4.3. Maximum speed setting

Select the TOP SPEED, and then press the key  to enter the Maximum Speed Setting page.



This item can be adjusted only by entering the password, which can be selected as 20KM/H, 25HK/H and 32KM/H. Please consult the dealer or vehicle manufacturer for the password.

### 6.4.4. Battery information.

Select the BATTERY INFO, and then press the key  to enter the BATTERY information display page.

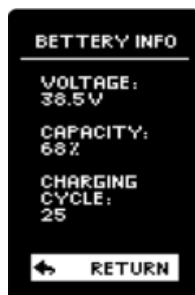



---

## Specification of H102 display

---

Display current battery voltage, battery capacity, number of charging cycles. If the battery is not recommended by the manufacturer, the battery information may not be displayed properly.



### 6.4.5. System version

Select the VERSION, and then press the key  to enter the Version information display page.



Display the hardware version and the software version, respectively.

### 6.4.6. Hidden assistant level setting

Select the PAGE DOWN, and then press the key  to enter the next Settings page, select HIDE LEVEL, and then press  again.



Select ON to turn on the hidden gear function, and select OFF to turn off the hidden gear function. If ON is selected, the adjustable range of the gear

## Specification of H102 display

---

in the main interface is 0-5. If OFF is selected, the adjustable range of the power gear is 0-6.

### 6.4.7. Mode setting

Select the MODE, and then press the key  to enter the Mode setting item.





SPEED mode or TORQUE mode can be selected depending on the type of power sensor. Default SPEED mode.

### 6.4.8. Single mileage reset

Select the TRIP, and then press the key  to enter the TRIP page.



Press the key  and  at the same time for more than 2 seconds to clear the single mileage value.

## 7. Common questions and solutions

Q: why can't you turn it on?

Answer: the boot needs to hold down the power button for 2 seconds. If you can't turn on the check table wire beam and the controller's connector contact is secure.

Q: how should the instrument display the fault code?

A: please check the corresponding faults according to the fault description and control check. If you can't solve it, please send the vehicle to the nearest dealer.

Q: the operating instrument has no response and how to handle it.

Answer: Long presses the power key more than 2 seconds, turns on again.



## *Warranty*

Your MAGNUM E-bike comes with a limited warranty. Please visit [www.magnumbikes.com](http://www.magnumbikes.com) or your local magnum dealer for details.

Bike must be registered at [www.magnumbikes.com/warranty](http://www.magnumbikes.com/warranty) in order to be covered by the one year warranty.

## *Stay Connected*

 @magnumbikes

 @magnumbikes

 [www.magnumbikes.com](http://www.magnumbikes.com)

 [info@magnumbikes.com](mailto:info@magnumbikes.com)

 323-375-2666